



MP7640 Multimedia Projector

Operator's Guide

MP7640 Projecteur multimédia Guide de l'opérateur

MP7640 Multimedia-Projektor Benutzerhandbuch

Projector de Multimedia MP7640 Manual del Usuario

MP7640 Proiettore Multimediale Manuale dell'operatore

MP7640 Bruksanvisning för multimediprojektor

MP7640 Multimedia Projector Gebruiksaanwijzing

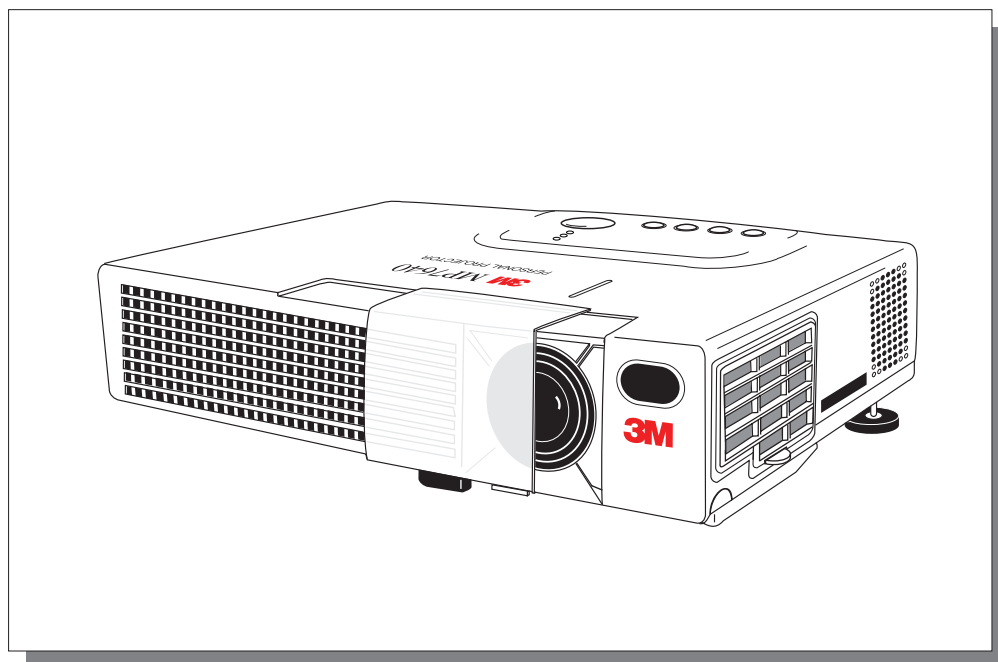

Please click on any section to jump to that section.

Introduction

Safeguards	4
Thank You for Choosing 3M	6
Warranty	6

Section 1: Unpack

Contents of Shipping Box	7
Optional Accessories	7
Keep Your Packing Materials	7
What's Next?	7

Section 2: Product Description

Machine Characteristics	8
Part Identification List	9
System Setup—Connecting to Various Equipment	10
Remote Control Transmitter Identification	11
Changing Remote Control Battery	12

Section 3: Basic Operations

Projector Startup	13
Projector Shutdown	13

Section 4: Adjustments and Functions

How to Use Height Adjustment Foot	14
Plug & Play Function	15
Freeze Function	15
Magnify Function	15
Menu Navigation	16
Factory Default Setting	16
SETUP Submenu	17
INPUT Submenu	18
IMAGE Submenu	19
OPT Submenu	20

Section 5: Maintenance

Cleaning the Air Filter	21
-------------------------------	----

Section 6: Lamp

Lamp	22
Display Lamp Operation Hours	22
Reset Lamp Hours	22
Replacing the Lamp	23

Section 7: Troubleshooting

Symptom/Solution Table	24
Message/Solution Table	24
Service Information	26

Section 8: Accessories

The Appendix is in English only.
Please click here to read it.

Introduction

Intended Use

Before operating the machine, please read this entire manual thoroughly. The 3M™ Multimedia Projector MP7640 was designed, built, and tested for use indoors, using 3M lamps, 3M ceiling mount hardware, and nominal local voltages. The use of other replacement lamps, outdoor operation, operation in environments containing heavy cigarette smoke or different voltages has not been tested and could damage the projector or peripheral equipment and/or create a potentially unsafe operating condition.

Important Safeguards

1. Read and understand all instructions before using. Pay particular attention to areas where these symbols are shown:

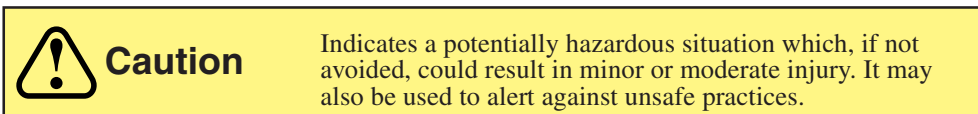

✓ *Note* - Used to emphasize important conditions or details.

2. Close supervision is necessary when any appliance is used by or near children. Do not leave appliance unattended while in use.
3. Never look directly into the projector lens when the lamp is on. The mercury lamp produces a strong light that could damage your eyesight.

- ⚠ 4. Care must be taken, as burns can occur from touching hot parts.

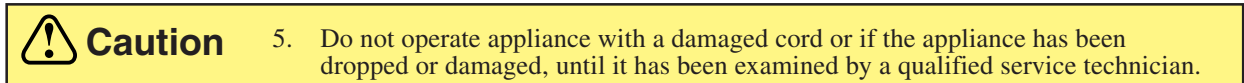

- ⚠ 6. Position the cord so that it will not be tripped over, pulled or placed in contact with hot surfaces.
7. If an extension cord is necessary, a cord with a current rating at least equal to that of the appliance should be used. Cords rated for less amperage than the appliance may overheat.
 8. Always unplug appliance from electrical outlet before cleaning and servicing and when not in use. Grasp plug and pull to disconnect.
 9. To reduce the risk of electric shock, do not immerse this appliance in water or other liquids.
 10. To reduce the risk of electric shock, do not disassemble this appliance. Take it to a qualified technician when service or repair work is required. Incorrect reassembly can cause electric shock when the appliance is subsequently used.
 11. Connect this appliance to a grounded outlet.
 12. Do not expose this projector to direct sunlight or use it outside.
- ⚠ 13. Keep all ventilation openings free of any obstructions.
14. Always open the lens shutter or remove the lens cap when the projector lamp is on.
 15. Do not look directly into light beam of laser pointer. The pointer produces a strong light which could damage your eyesight.
 16. The projection lamp contains mercury. Always dispose of it in a proper manner according to local regulations.
 17. To prevent lamp from bursting, do not continue using the same lamp after changing the mounting position of the projector (desktop to ceiling mount or ceiling mount to desktop mount).
 18. Always operate machine on a flat, sturdy surface.

Introduction

Location of Product Safety Labels

The following safety labels are used on or within the MP7640 projector to alert you to items or areas requiring your attention.

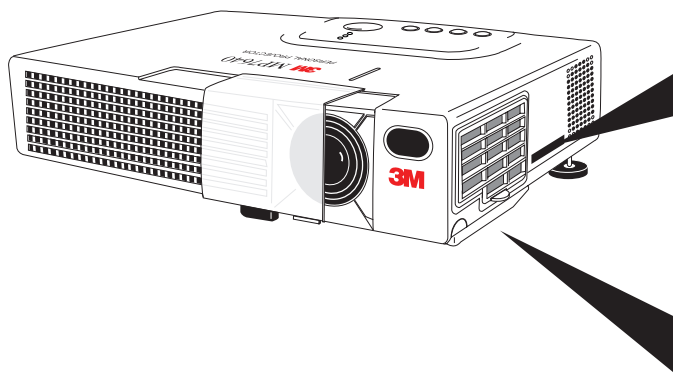

CAUTION/VORSICHT/MESURE DE PRÉCAUTION/ATTENZIONE/PRECAUCIÓN
Turning the knob too much makes it come off. / Der Verstellknopf löst sich wenn er überdreht wird. / Si vous manipulez excessivement la poignée, elle se détachera. / Se si gira troppo la manopola si stacca. / Grandola demasiado la manivela se desprende.
H ← L

HIGH TEMPERATURE / HAUTE TEMPERATURE / HOCHTEMPERATUR / ALTA TEMPERATURA / ALTA TEMPERATURA **3M**

- When replacing lamp, turn off and unplug unit, wait 45 minutes to let lamp cool. High-pressure lamp when hot, may explode if improperly handled.
- Pour changer la lampe, éteindre et débrancher la machine. Attendre 45 minutes de manière à laisser refroidir la lampe. La lampe haute pression risque d'exploser si elle est manipulée sans précaution lorsqu'elle est encore chaude.
- Vor Austausch der Lampe, das Gerät abschalten und den Stecker herausziehen; 45 Minuten warten, warten, um die Lampe abkühlen zu lassen. Falls die heiße Hochdrucklampe falsch gehandhabt wird, kann sie explodieren.
- Prima di sostituire la lampadina, spegnere il proiettore, scollegarne la presa di alimentazione ed attendere 45 minuti circa che la lampadina si raffreddi. Se calda, essa è sottoposta ad alta pressione interna e può esplodere.
- Cuando tenga que reemplazar la lámpara, desconecte la alimentación y desenchufe la unidad, y espere 45 minutos para dejar que se enfríe la lámpara. La lámpara, que está a alta presión cuando está caliente, puede explotar si se manipula indebidamente.

Caution

In some countries, the line voltage is NOT stable. This projector is designed to operate safely within a bandwidth of 110 to 230 volts \pm 10 volts, but could fail if power drops or surges of \pm 10 volts occur. In these high-risk areas, it is recommended to install a power stabilizer unit.

Save These Instructions

The information contained in this manual will help you operate and maintain your 3M™ MP7640 Multimedia Projector.

Introduction

Thank You for Choosing 3M

Thank you for choosing 3M multimedia projection equipment. This product has been produced in accordance with 3M's highest quality and safety standards to ensure smooth and troublefree use in the years to come.

For optimum performance, please follow the operating instructions carefully. We hope you will enjoy using this high performance product in your meetings, presentations, and training sessions.

Warranty

Limited Warranty

3M warrants this product against any defects in material and workmanship, under normal usage and storage, for a period of two years from date of purchase. **Exclusion to Warranty:** The lamps are considered a consumable item and are warranted for 90 days or 180 hours, whichever occurs first. Proof of purchase date will be required with any warranty claim. In the event this product is found to be defective within the warranty period, 3M's only obligation and your exclusive remedy shall be replacement of any defective parts (labor included). To obtain warranty service, immediately notify the dealer from which you purchased the product of any defects. In the USA call 1-800-328-1371 for warranty or repair service.

Limitation Of Liability

THE FOREGOING WARRANTY IS MADE IN LIEU OF ALL OTHER WARRANTIES, EXPRESSED OR IMPLIED, AND 3M SPECIFICALLY DISCLAIMS ANY IMPLIED WARRANTY OF MERCHANTABILITY AND FITNESS FOR A PARTICULAR PURPOSE. 3M SHALL NOT BE LIABLE FOR ANY DAMAGES, DIRECT, CONSEQUENTIAL, OR INCIDENTAL, ARISING OUT OF THE USE OR INABILITY TO USE THIS PRODUCT.

Important: The above warranty shall be void if the customer fails to operate product in accordance with 3M's written instructions. This warranty gives you specific legal rights, and you may have other rights which vary from state to state.

FCC STATEMENT - CLASS B: This equipment generates, uses and can radiate radio frequency energy and, if not installed and used in accordance with the instructions, may cause harmful interference to radio communications. However, there is no guarantee that interference will not occur in a particular installation. If this equipment does cause harmful interference to radio or television reception, which can be determined by turning the equipment off and on, the user is encouraged to try to correct the interference by one or more of the following measures:

- Reorient or relocate the receiving antenna.
- Increase the separation between the equipment and receiver.
- Connect the equipment into an outlet on a circuit different from that to which the receiver is connected.
- Consult the dealer or an experienced radio/TV technician for help.

Instructions to Users: This equipment complies with the requirements of FCC (Federal Communication Commission) equipment provided that following conditions are met. The cables (power cord, RGB cable and other cables) may have to be used with the core set to the projector side. Use the cables which are included with the projector or specified.

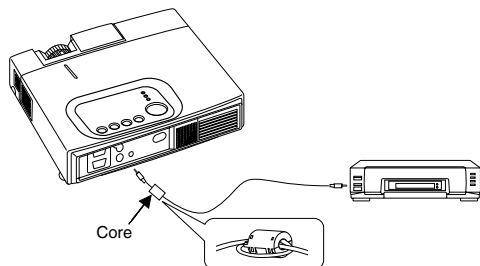

Caution

Changes or modifications not expressly approved by the party responsible for compliance could void the user's authority to operate the equipment.

For customers in Canada

NOTICE: This Class B digital apparatus complies with Canadian ICES-003.

Pour les utilisateurs au Canada

AVIS: Cet appareil numérique de la Classe B est conforme à la norme NMB-003 du Canada.

EEC STATEMENT: This machine was tested against the 89/336/EEC (European Economic Community) for EMC (Electro Magnetic Compatibility) and fulfills these requirements.

Video Signal Cables: Double shielded coaxial cables (FCC shield cable) must be used, and the outer shield must be connected to the ground. If normal coaxial cables are used, the cable must be enclosed in metal pipes or in a similar way to reduce the interference noise radiation.

Video Inputs: The input signal amplitude must not exceed the specified level.

Patents, Trademarks & Copyrights

IBM is a registered trademark of **International Business Machines Corporation**. **Apple Macintosh** and **Apple Powerbook** are registered trademarks of **Apple Computer, Inc.** **Microsoft** and **Windows 95** and **Windows 98** are registered trademarks, and **Windows** and **Windows for Workgroups** are trademarks of the **Microsoft Corporation**. **Toshiba** is a registered trademark of **Toshiba Corporation**. All other products are trademarks or registered trademarks of their respective companies.

Section 1: Unpack

Contents of Shipping Box

The 3M™ MP7640 Multimedia Projector is shipped with the necessary cables required for standard VCR, PC, Macintosh™ or laptop computer connections. Carefully unpack and verify that you have all of the items shown below. If any of these items are missing, please contact your place of purchase.

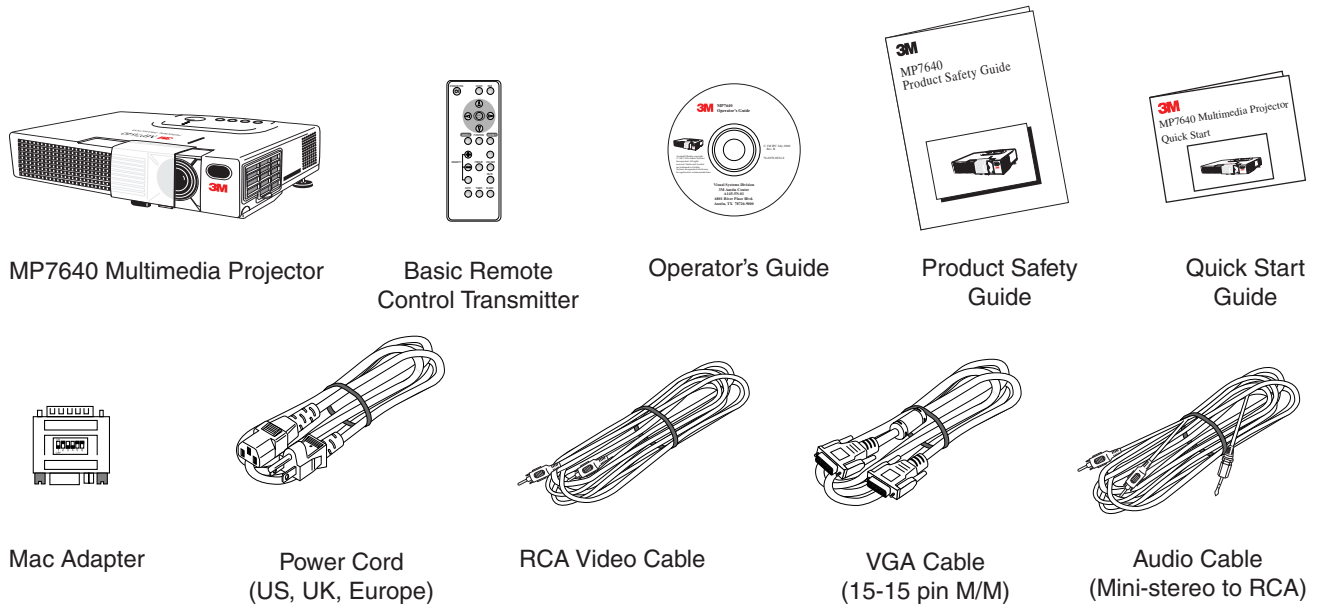

Figure 1.1 Inventory of Shipping Box

Optional Accessories

- RS-232 Control Cable (1)
- Deluxe Remote Control Transmitter .. (1)
- Remote Control Mouse Unit (1)
- Carrying Case (1)
- S-VHS Video Cable (1)

Keep Your Packing Materials

Save the shipping box and packing materials in the event the MP7640 should require shipping to a 3M Service Center for repair.

What's Next?

After you have unpacked the MP7640 and identified all the parts, you are ready to set up the projector.

Please read this guide thoroughly before operating your new projector.

Be sure to check our web site (www.3m.com/meetings) regularly for updates and supplemental information. On the CD-ROM, you can link directly to the web site by clicking [here](#) or on “3M Innovation” in the lower right corner of the Main Menu.

Section 2: Product Description

Machine Characteristics

The MP7640 Multimedia Projector integrates ultra-high bright lamp and polysilicon LCD display technology into a single unit. It accepts input from one computer source and two video/audio sources, and projects a bright, super-crisp image. Switching your presentation from a computer input to a video input, then back to a computer input simply requires the push of a button on the remote control keypad or control panel keypad.

The MP7640 Multimedia Projector offers the following features:

- UHB (ultra-high bright) projection lamp
- SVGA resolution (3 separate 800 x 600 LCD panels are used for the R, G and B signals)
- Intelligent XGA scaling (60 Hz and 75 Hz)
- Intelligent VGA scaling
- Compact size, lightweight for portability
- RGB (computer video) output terminal
- Manual zoom and focus functions
- 4x digital magnification
- Easy to set up and use
- Ability to display 16.7 million colors
- One computer input connection
- Two video input connections (composite and S-video compatible)
- Slim, lightweight remote control
- Eight blank-screen colors available
- One built-in speaker (1.0 watt)
- Horizontal and vertical image inverting function
- Horizontal and vertical image position control
- Digital keystone correction
- On-screen menu with nine languages
- Universal power supply
- IR sensor in front and rear for maximum remote control range
- RS-232 control capability
- Color balance control for data/video
- Plug & Play compatible
- Freeze function
- Kensington™ Slot  (Kensington microsaver needed)
- Aspect ratio 16:9, 4:3, or 4:3 small

✓ **Note:** *The MP7640 is one of the brightest personal projectors in the marketplace. The brightness of your machine will vary depending on the ambient room conditions and contrast/brightness settings.*

Section 2: Product Description

Part Identification List

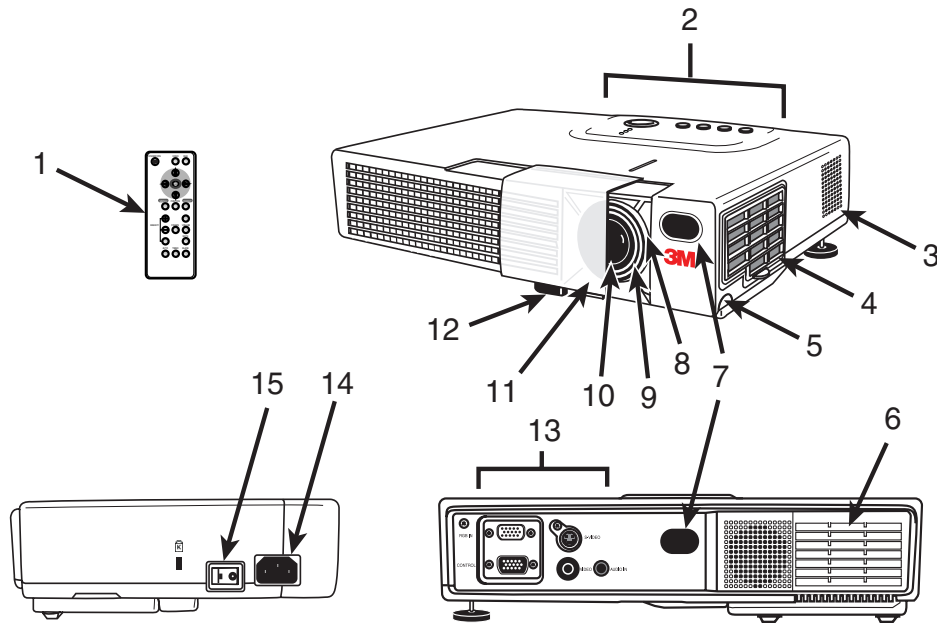

Figure 2.1 Identifying MP7640 Parts

1. Basic remote control transmitter
2. Control panel keypad (see below)
 - a) STANDBY/ON button
 - b) ON, LAMP, TEMP indicators
 - c) INPUT, MUTE, RESET buttons
 - d) MENU disk button
3. Stereo Speaker
4. Air filter cover
5. Height adjustment foot lock button
6. Cooling fan exhaust
7. Remote control sensors
8. Zoom knob
9. Focus ring
10. Projection lens
11. Sliding lens door
12. Height adjustment foot
13. Terminal connection panels
 - a) S-Video, Video, Audio input
 - b) RGB input
 - c) RS-232C, PS/2, Serial, ADB Control
14. AC power cord connection
15. Main power switch

Control Panel Keypad Buttons

The control panel keypad is located on top of the projector.

- Press the Standby/On button to turn the projector off and on.
- Press the Input button to select the source of the signal to be displayed onscreen. The type of signal will be displayed at the bottom right of the screen.
- Press the Mute button to turn the audio output off and on.
- Press the Reset button to return the projector to its default settings.
- Press the Menu disk pad button to access on-screen menus and select items. (For more information on this feature, see page 16.)

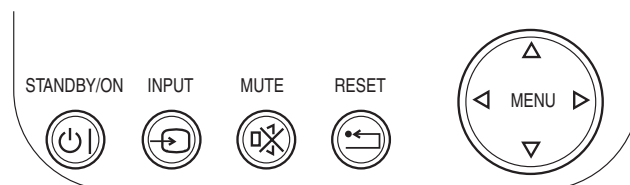

Section 2: Product Description

System Setup—Connecting to Various Equipment

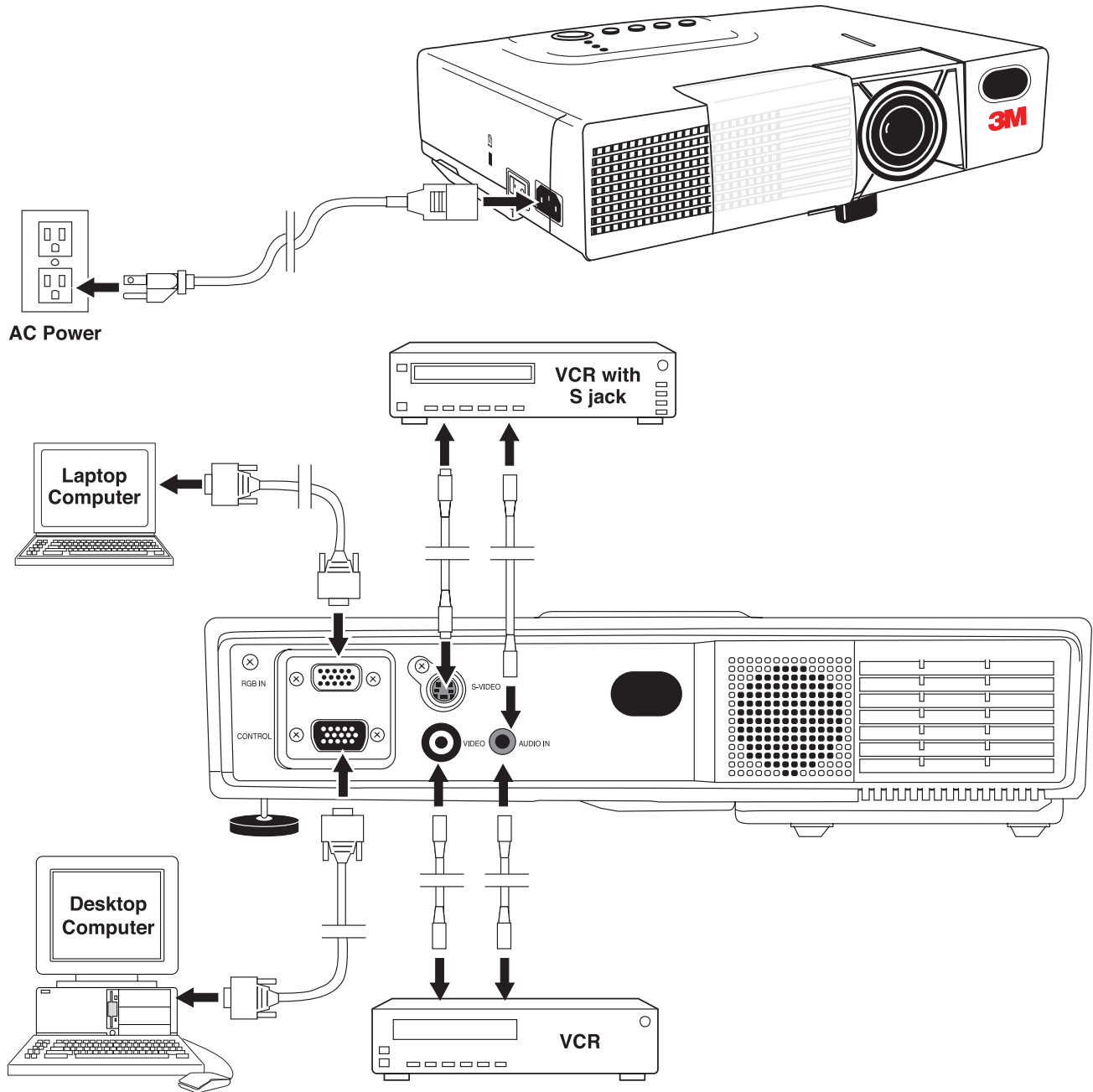

Figure 2.2 Cable Connections



Caution

Turn power off to all devices before making connections. Never plug anything into the projector or computer while any device is in operation.

The MP740 must be powered down when making connections. The mouse emulation may not work if the unit is not powered down before the mouse cable connections are made.

Section 2: Product Description

Remote Control Transmitter Identification

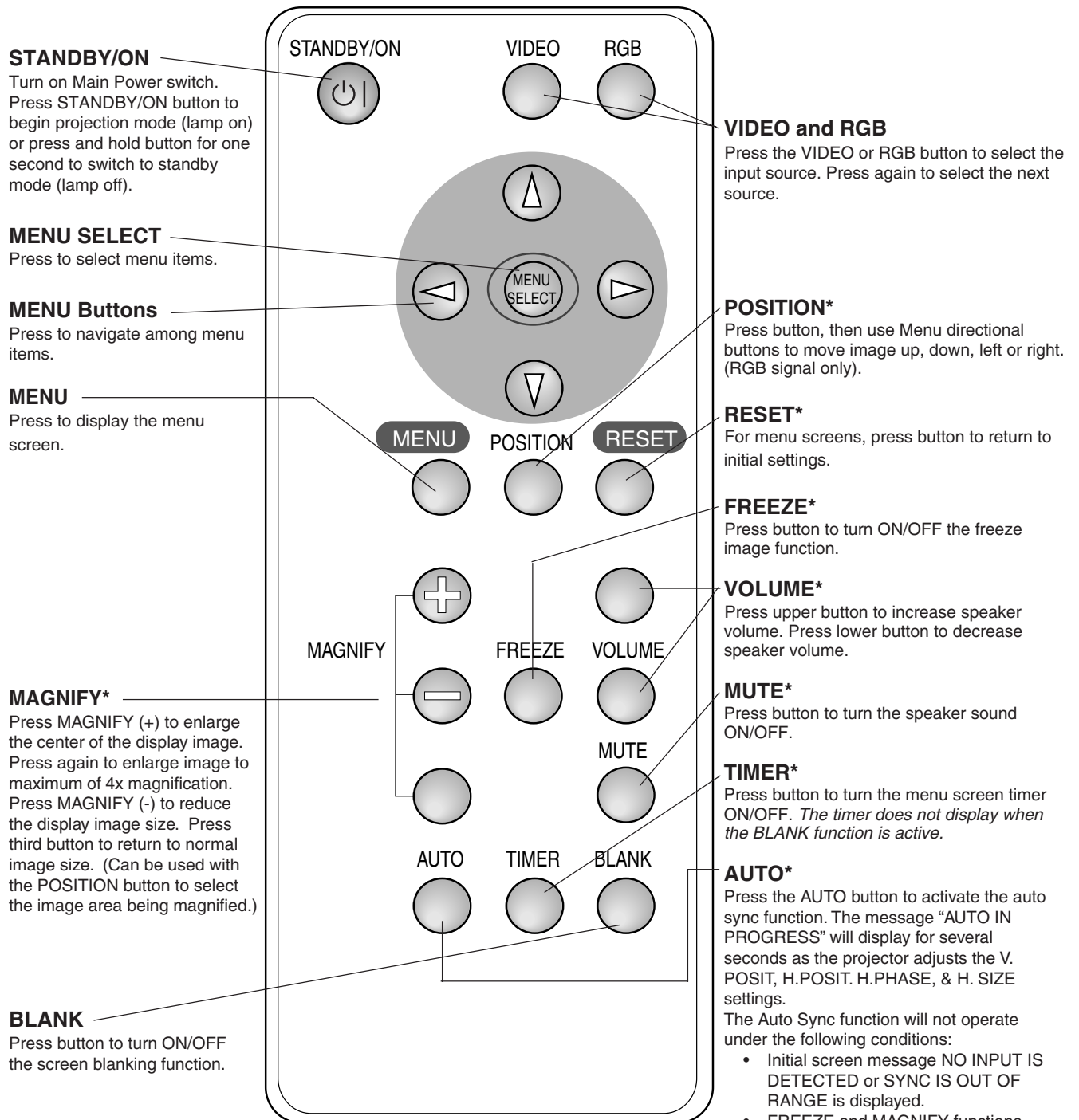

**This button will not function if the messages "NO INPUT IS DETECTED" or "SYNC IS OUT OF RANGE" are displayed.*

Figure 2.3 Basic Remote Control Transmitter

Section 2: Product Description

Changing Remote Control Battery



Caution

This battery contains lithium. Consult your local hazardous waste regulations and dispose of this battery in the proper manner.

This remote control transmitter uses a lithium battery located in a sliding holder inserted into the bottom of the transmitter.

1. Turn the remote control transmitter over to access the battery holder.
2. Push the smaller tab inward as indicated below.
3. Slide the battery holder out of the bottom of the transmitter.
4. Lift the battery out of the holder and replace with the new battery. Make sure the “+” side is facing up.
5. Slide the holder back into the transmitter until the tabs snap into place.



Caution

- Avoid excessive heat and humidity.
- Do not mix old and new batteries or different types of batteries.

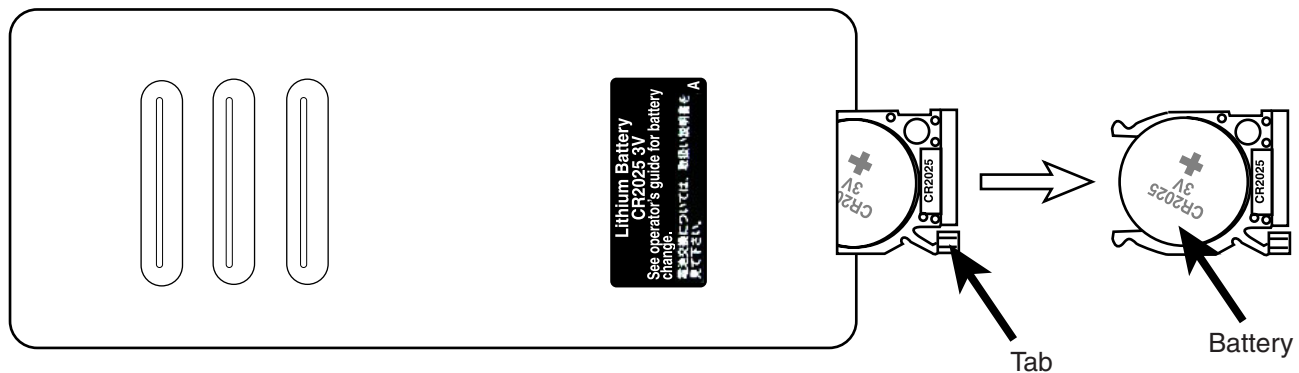

Section 3: Basic Operations

Projector Start-up

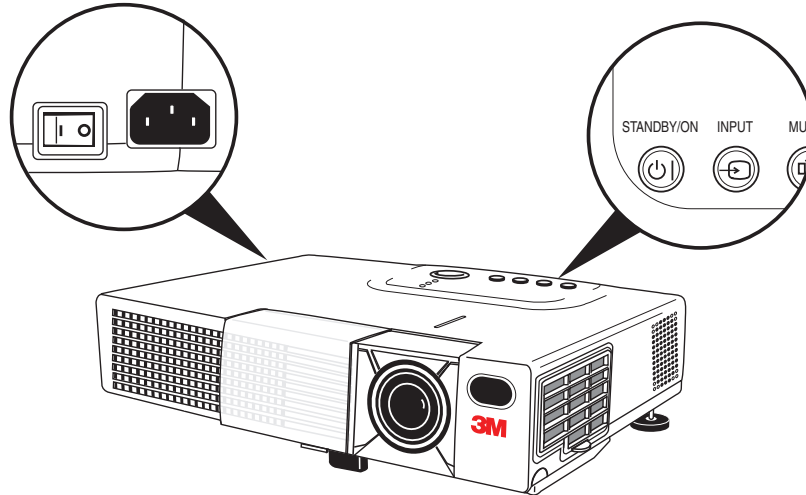







Figure 3.1 Projector Controls

1. Make all equipment and cable connections with the power off.
2. **Turn on the MAIN POWER SWITCH**  of the projector. The ON indicator will light up orange.
3. **Press the STANDBY/ON button** . The ON indicator will blink green during warm-up and lamp ignition, then stay green to indicate correct operation. When power is turned off, there is a 60-second reset period before the STANDBY/ON button will function again.
4. **Turn on all connected equipment.** (Refer to “System Set-up—Connecting to Various Equipment,” page 10.)
5. Open sliding lens door.
6. Press the INPUT button  on the projector or the INPUT SELECT (VIDEO or RGB) button on the remote control transmitter to select the source of the signal to be projected on the screen. The selected signal input is displayed at the bottom right of the screen. The display will show the last selected input source before power was turned off.
7. Adjust picture size using the projection lens Zoom knob. Adjust focus using the projection lens Focus ring.

Projector Shutdown

1. **Press and hold the STANDBY/ON button**  **for one second.** The ON indicator blinks orange and the lamp turns off. After approximately one minute, the fan stops and the indicator stays orange.
2. Turn off the **MAIN POWER SWITCH**. 
3. Close the sliding lens door.



Caution

Do not turn off the POWER SWITCH before pressing the STANDBY/ON button. After the STANDBY/ON button is pressed, the fan rotates for about one minute to cool the projector.

Section 4: Adjustments and Functions

How to Use Height Adjustment Foot

Adjust the image elevation and projection angle (within 0 to 10°) using the height adjustment foot at the front of the projector.

1. Raise the front end of the projector so the foot is not touching the tabletop.
2. Push the lock button on the left side of the projector to unlock the foot.
3. Extend or retract the foot to the desired height.
4. Release the lock button to lock the foot into position.
5. For finer adjustment, rotate the tilt adjustment knob on the left rear foot of the projector.



Caution Do not unlock the foot adjuster if the projector is not supported.

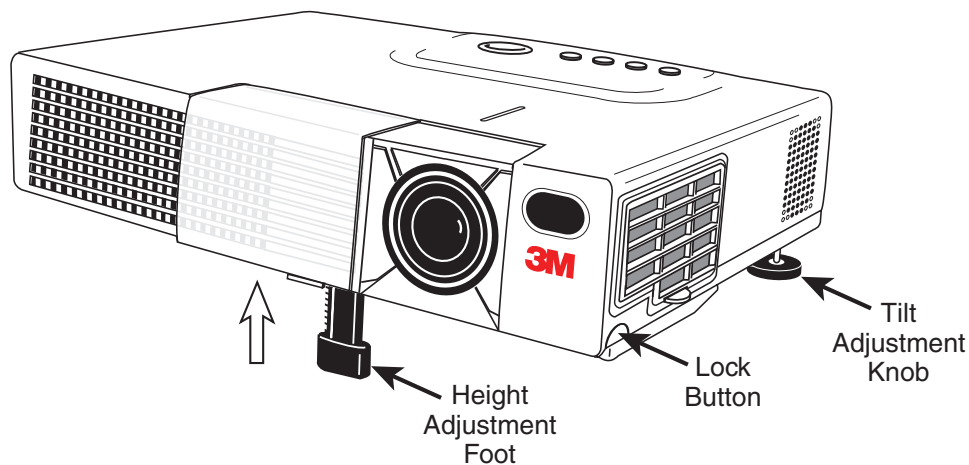

Figure 4.1 Height Adjustment

Screen Size			Distance to Screen	
Width	Height	Diagonal	Minimum	Maximum
81.2 cm (32 in.)	60.9 cm (24 in.)	101.6 cm (40 in.)	94.4 cm (3.1 ft.)	115.8 cm (3.8 ft.)
121.9 cm (48 in.)	91.4 cm (36 in.)	152.4 cm (60 in.)	146.3 cm (4.8 ft.)	176.7 cm (5.8 ft.)
162.5 cm (64 in.)	121.9 cm (48 in.)	203.2 cm (80 in.)	195.0 cm (6.4 ft.)	237.7 cm (7.8 ft.)
203.2 cm (80 in.)	152.4 cm (60 in.)	254 cm (100 in.)	243.8 cm (8.0 ft.)	295.6 cm (9.7 ft.)
243.8 cm (96 in.)	182.8 cm (72 in.)	304.8 cm (120 in.)	295.6 cm (9.7 ft.)	353.5 cm (11.6 ft.)
304.8 cm (120 in.)	228.6 cm (90 in.)	381.0 cm (150 in.)	368.8 cm (12.1 ft.)	441.9 cm (14.5 ft.)
406.4 cm (160 in.)	304.8 cm (120 in.)	508 cm (200 in.)	493.7 cm (16.2 ft.)	591.3 cm (19.4 ft.)

Figure 4.2 Height Adjustment

Section 4: Adjustments and Functions

Plug & Play Function

Plug & Play is a system configured with peripheral equipment (including a computer and display), and a compatible operating system. This allows the user to connect various peripheral equipment successfully without having to adjust settings manually. The equipment and projector exchange this information automatically. This projector is VESA DDC (Display Data Channel) 1/2B compatible. Plug & Play is possible by connecting to a computer that is VESA DDC compatible.

✓ **Note:** *Use the RGB cable included with this projector when using plug & play. With other cables, pins (12) - (15) are sometimes not connected (effective only for RGB1).*

Freeze Function

The Freeze function is used to display (freeze) a single frame of the image being projected. This function can be used with the Magnify function to freeze the image and then enlarge (magnify) part of the image to view it in greater detail. Press the FREEZE button repeatedly to engage or disengage this function.

✓ **Note:** *The FREEZE function will turn off during the operation of the MENU, FOCUS, VOLUME, MUTE, BLANK, TIMER, AUTO or POSITION functions.*

Magnify Function

The Magnify function is used to enlarge a portion of the projected image. Press the MAGNIFY (+) button to magnify the center of the displayed image. Press again to magnify up to 4x. Press the MAGNIFY (-) button to reduce image size. Press OFF to return to normal image size. To move the display area being magnified, press the POSITION button, then use the DISC PAD to move the magnified area up, down, left or right.

✓ **Note:** *To return to normal display, press the MAGNIFY OFF button. The MAGNIFY function will turn off during the operation of the KEYSTONE or AUTO functions.*

Section 4: Adjustments and Functions

Menu Navigation

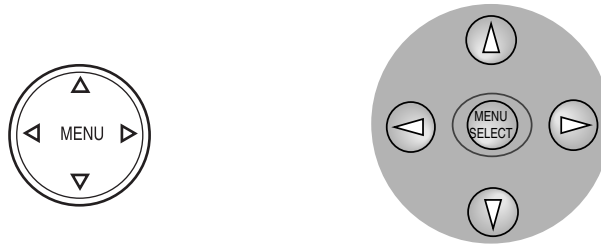









Figure 4.3 Menu disk button on projector and Menu buttons from basic remote control transmitter

1. **Press MENU disk button on projector or remote control MENU buttons.**
On-screen menus are displayed on the projected image.
 2. **Select the menu to be adjusted using the MENU disk button or remote control Menu buttons**  .
 3. **Select the menu item to be adjusted using the MENU disk button or any of the remote control Menu buttons**    .
- Highlighted items may be adjusted.
- ✓ **Note:** *Separate settings are provided for the VIDEO and RGB input terminals. Adjustments are saved after shutdown.*

Press MENU SELECT on the remote control to view the full menu or just the selected menu item. When only the selected menu item is displayed, the other menu items are displayed by pressing the   buttons.



Factory Default Setting:

To reset a single item from SETUP menu:

1. Select the adjustment item (Bright, Contrast...).
2. Press the RESET button. **Only the selected item resets.**

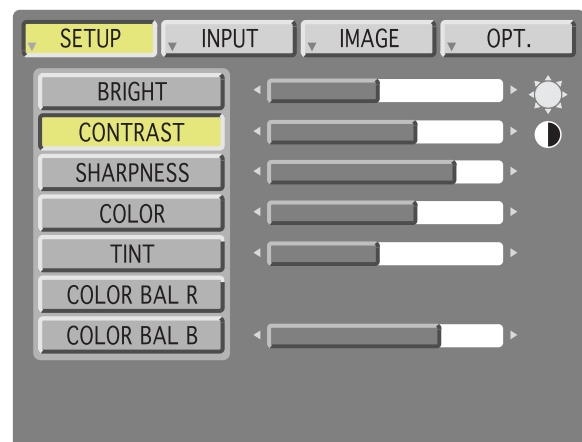

Figure 4.4 Default Settings

Section 4: Adjustments and Functions

SETUP Submenu

The SETUP sub-menu is used to adjust and move the image position. The projector will display either the RGB (Figure 4.5) or Video (Figure 4.6) submenu, according to the input source being projected.

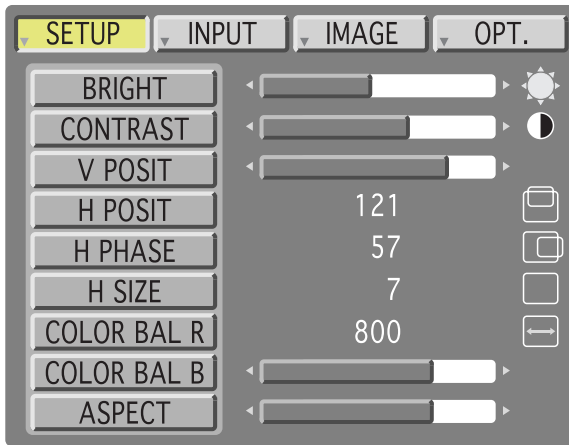

Figure 4.5 RGB signal input

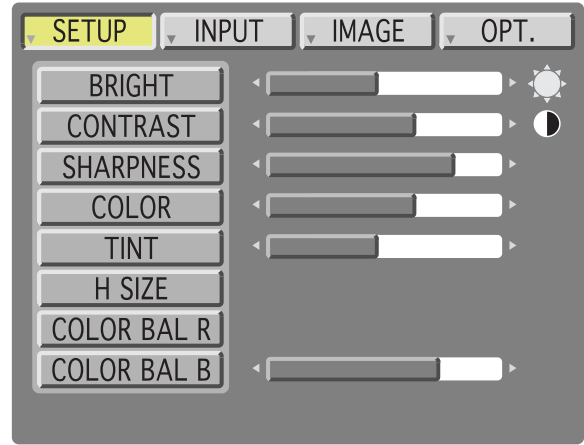

Figure 4.6 Video signal input

Adjustment Item	Details of Adjustment	Freeze On	Magnify On	Both On
BRIGHT (BRIGHTNESS)	Dark ← → Bright	Adjustable	Adjustable	Adjustable
CONTRAST	Lower ← → Higher	Adjustable	Adjustable	Adjustable
V.POSIT (V.POSITION)	Moves the picture up or down.*	Not Adjustable	Not Adjustable	Not Adjustable
H.POSIT (H.POSITION)	Moves the picture left or right.*	Not Adjustable	Not Adjustable	Not Adjustable
H.PHASE	Decreases the picture flicker.*	Not Adjustable	Adjustable	Not Adjustable
H.SIZE	Widens or Narrows the horizontal size of picture.*	Not Adjustable	Not Adjustable	Not Adjustable
SHARPNESS	Soft ← → Sharp	Not Adjustable	Adjustable	Not Adjustable
TINT	Red ← → Green	Not Adjustable	Adjustable	Not Adjustable
COLOR	Less ← → More	Not Adjustable	Adjustable	Not Adjustable
COLOR BAL R	Less red ← → More red	Adjustable	Adjustable	Adjustable
COLOR BAL B	Less blue ← → More blue	Adjustable	Adjustable	Adjustable
ASPECT	4:3, 4:3 small, 16:9	Not Adjustable	Not Adjustable	Not Adjustable

***Auto Sync Function:** Press the AUTO button on the remote control to engage the automatic sync function. The message “AUTO IN PROGRESS” will display for several seconds as the projector adjusts the V. POSIT, H.POSIT., H.PHASE, and H. SIZE settings. Auto Sync can also be executed from the control panel key pad. Press and hold the RESET button, then press the INPUT button.

✓ **Note:**

- *TINT cannot be adjusted with a PAL or M-PAL video signal input.*
- *TINT, COLOR, and SHARPNESS cannot be adjusted with an RGB signal input.*
- *V. POSIT, H. POSIT, H. PHASE, and H. SIZE cannot be adjusted with a VIDEO signal input.*
- *Menu operation is not possible during Freeze functions.*
- *Displaying the SETUP submenu will cancel the Magnify and Freeze functions.*

Section 4: Adjustments and Functions

INPUT Submenu

The INPUT submenu is used to select the RGB or video input source. The RGB values are shown in Figure 4.7. The Video values are shown in Figure 4.8.

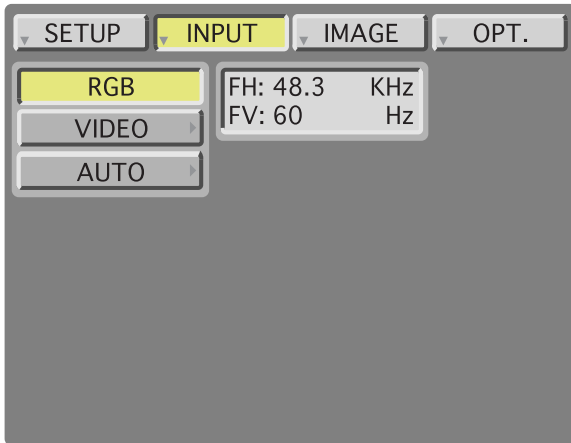

Figure 4.7 RGB Input Submenu

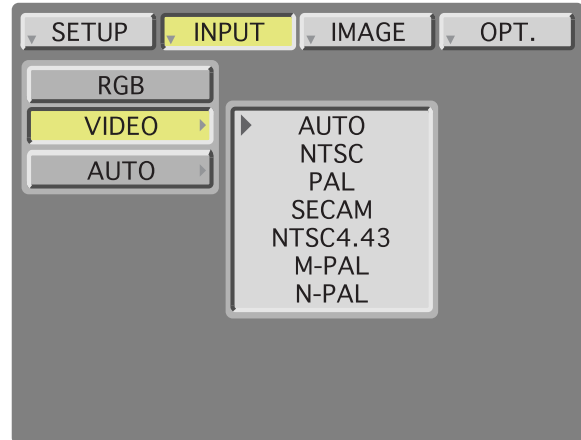

Figure 4.8 Video Input Submenu

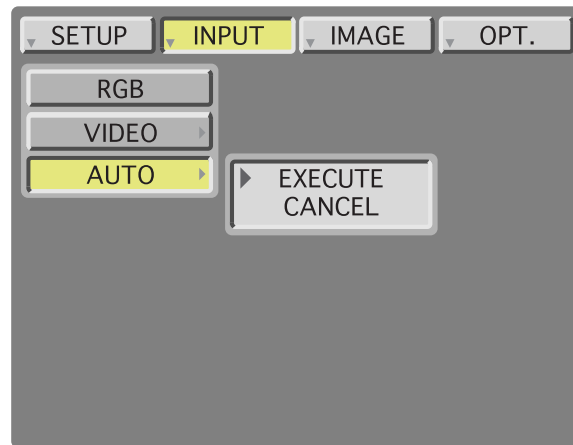

Figure 4.9 Auto Input Submenu

Adjustment Area	Value
RGB	Displays the following RGB inputs: FH: horizontal sync frequency FV: vertical sync frequency
Video	Selects the VIDEO signal format Auto, NTSC, PAL, SECAM, NTSC 4.43, M-PAL, N-PAL
Auto	Selects EXECUTE or CANCEL for Auto signal input detection.

Section 4: Adjustments and Functions

IMAGE Submenu

The IMAGE submenu is used to change the image characteristics.

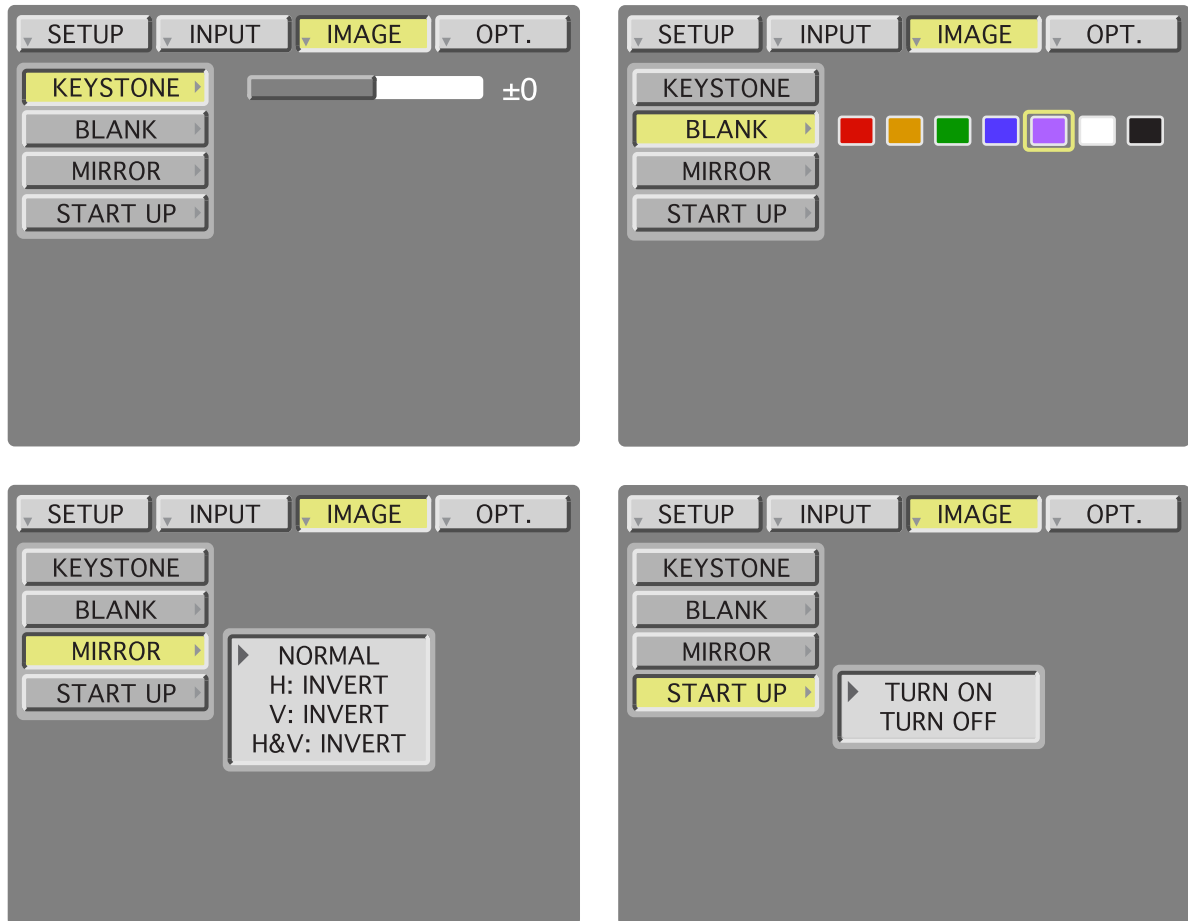

Figure 4.10 Image Adjustment Screens

Adjustment Screen	Value
KEystone	Reduce distortion at bottom of image. \longleftrightarrow Reduce distortion at top of image.
BLANK	Selects the blank screen color: red, orange, green, blue, purple, white or black.
MIRROR	Inverts the picture horizontally or vertically. H: INVERT Inverts the picture horizontally. V: INVERT Inverts the picture vertically. H&V: INVERT Inverts the picture horizontally and vertically.
STARTUP	Enable / Disable startup screen. When canceled, the background color will change to blue.

Section 4: Adjustments and Functions

OPT. Submenu

The OPT. submenu allows you to control communication function.

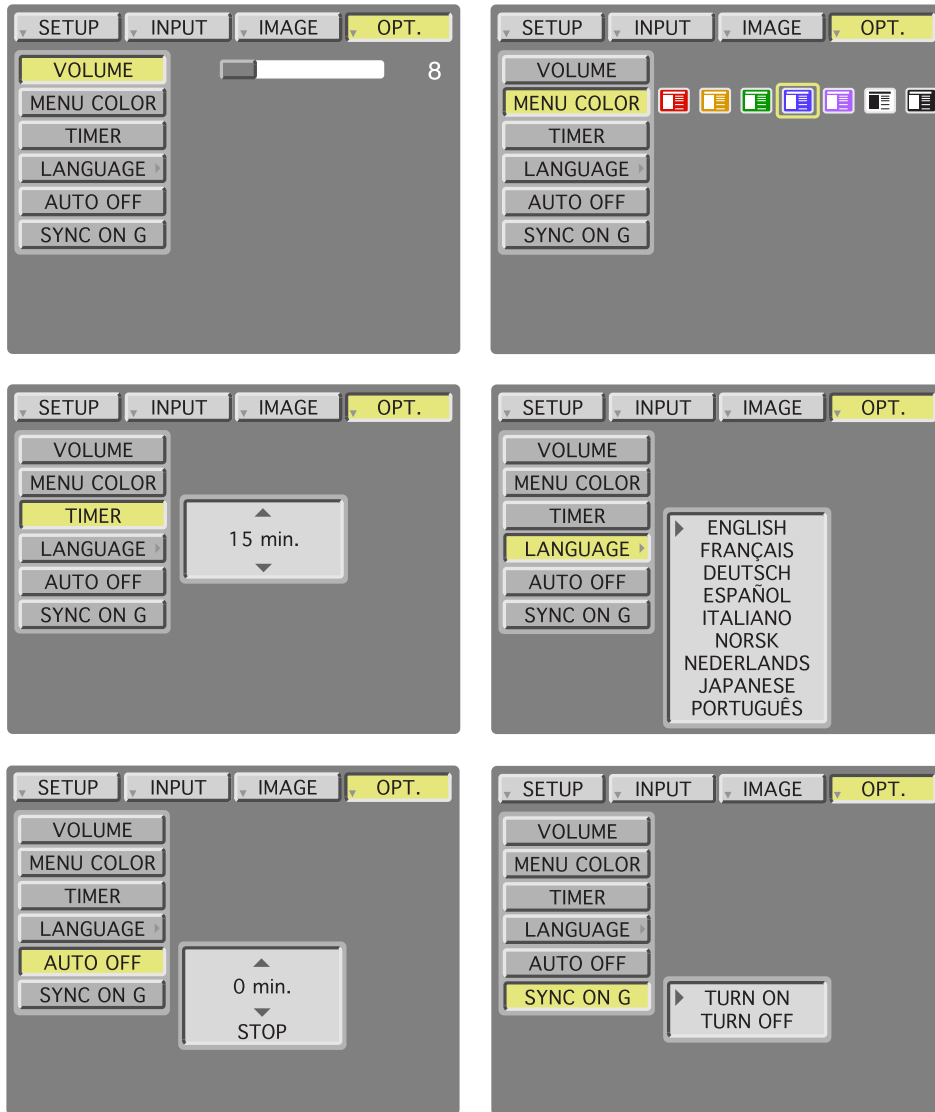

Figure 4.11 OPT Adjustment Screens

Adjustment Screen	Value	Default
VOLUME	Adjusts the loudness of audio coming through the speaker.	8
MENU COLOR	Selects the background color in which the menu system will be displayed. Choice of red, orange, green, blue, purple, white and black. (All menus have white text except white menu, which will have black.)	Blue
TIMER	Sets the timer (0-15 minutes).	—
LANGUAGE	Selects the language on-screen menu. (English, French, German, Spanish, Italian, Norwegian, Netherlands, Japanese, and Portuguese)	—
AUTO OFF	Selects how long projector will stay on in minutes, if no input is detected. Select 0 to disable this function.	—
SYNC ON G	Sets the SYNC on G function to ON/OFF (for older Apple computers).	—

Section 5: Maintenance

Cleaning the Air Filter

✓ *Note: Clean the air filter about every 50 hours or if the message “CHECK AIR FLOW” is displayed on the screen. If air is restricted due to dust accumulation on filter, the projector may overheat and shut down automatically.*

Turn off the **MAIN POWER SWITCH** of the projector and pull out power cord. Let cool for 20 minutes. Vacuum dust and dirt from filter.

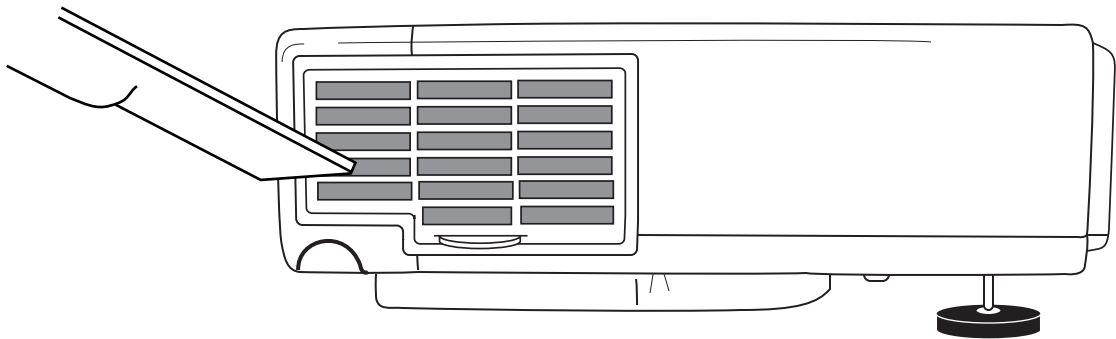

Figure 5.1 Cleaning Air Filter

Section 6: Lamp

Lamp

The following symptoms may indicate that the lamp needs to be replaced:

- LAMP indicator lights up red.
- “CHANGE THE LAMP” message appears on the screen.

Display Lamp Operation Hours

To determine the lamp operation hours:

1. While the projector is running, press and hold the TIMER button on the remote control for three seconds.
2. The operating time of the lamp will be displayed at the bottom of the screen. The message “CHANGE THE LAMP, AFTER REPLACING LAMP RESET THE LAMP TIMER” will appear after the lamp has reached the end of the normal lamp life. The message “POWER WILL TURN OFF AFTER **20** HOURS” will appear when 20 or less lamp hours remain. The number of hours left until shutdown will decrease until **0** hour is reached, then power will turn off automatically.

✓ **Note:** *After normal lamp operating time has expired, the projector will only run for 10-minute intervals when restarted until the lamp is replaced and the lamp timer is reset. The message “CHANGE THE LAMP” will blink at projector start-up to remind you to change the lamp.*

Reset Lamp Hours

The lamp operation hours must be reset after changing the lamp. When the lamp has been replaced after the LAMP indicator is red, or the CHANGE THE LAMP message displayed, you must complete the following within 10 minutes after switching on the power. Otherwise, the power will automatically shut down after 10 minutes.

1. To display the total lamp hours, press the RESET button on the projector or the Timer button on the remote control and hold for three seconds. The “LAMP xxxx hr” message will display at the bottom of the screen.
2. To reset the lamp timer, press the RESET button on the projector or MENU button on the remote while the lamp hours are displayed. The lamp hour reset message will display. Use the left-arrow button on the remote control or the Menu diskpad of the projector to select 0, and wait until the timer display has cleared.

Section 6: Lamp

Replacing the Lamp



WARNING

To reduce the risk of electrical shock, always turn off projector and disconnect power cord before changing lamp.

✓ **Note:** For maximum lamp life, do not shock, handle or scratch the lamp glass when it is hot. Do not use an old or previously used lamp as a replacement lamp.

1. **Remove lamp access door:** The lamp access door is located on the bottom of the machine. Use a screwdriver to loosen the lamp access door retaining screw, gently remove the door, and set it aside.

2. Use a screwdriver to loosen the lamp module retaining screw.

✓ **Note:** These screws are self-containing screws that cannot be removed from the lamp module or access door.

3. **Remove lamp module:** Carefully slide the lamp module out by pulling straight up on the retaining wire on top of the module.

4. **Insert lamp module:** Carefully insert the new lamp module by sliding it straight down into the opening. Ensure that it is fully seated. Tighten the lamp module retaining screw to secure the lamp module in place.

5. Insert the hinge tabs on the bottom of the lamp access door, close, and tighten the retaining screw to secure the door.

✓ **Note:** Reset the lamp operation hours. See the previous page for details.

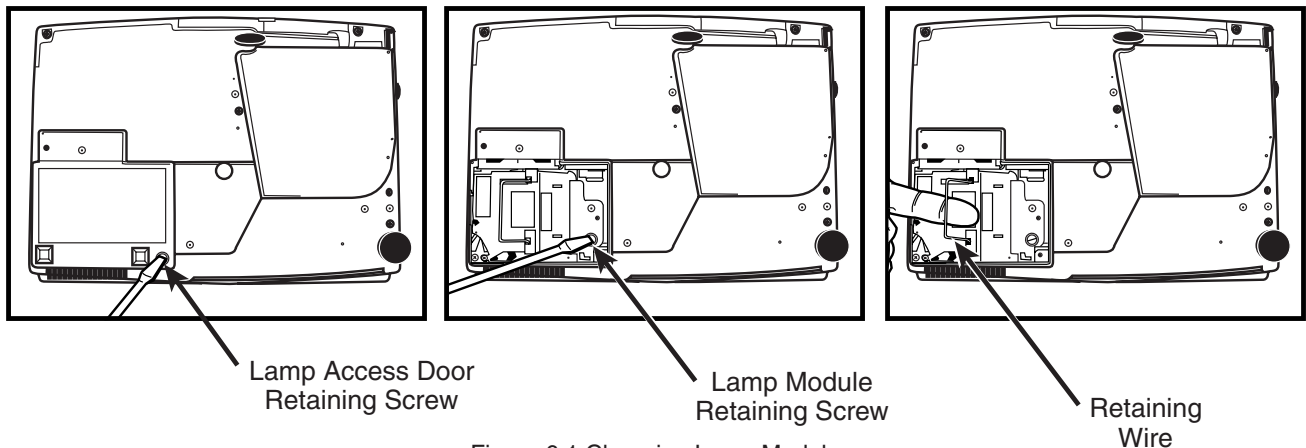

Caution

This lamp contains mercury. Consult your local hazardous waste regulations and dispose of this lamp in the proper manner.

Section 7: Troubleshooting

Symptoms/Solutions

Symptom	Cause	Solution
Power cannot be turned on.	<ul style="list-style-type: none"> • MAIN POWER switch is not turned on. • The power cord is disconnected. • 60 seconds have not elapsed since the power was turned off. 	<ul style="list-style-type: none"> • Turn the MAIN POWER switch on. • Insert the power cord into an AC socket. • Wait 60 seconds before turning on power.
No picture or sound.	<ul style="list-style-type: none"> • The setting of the input source is not correct. • RGB/Video/Audio wiring to projector is not correct. 	<ul style="list-style-type: none"> • Set the correct input using the input select button of the projector or the remote control. • Connect the cable to correct input/output source.
Sound is heard without picture.	<ul style="list-style-type: none"> • RGB/Video/Audio wiring to projector is not correct. • The brightness is set fully to dark. • Lens cap is on. 	<ul style="list-style-type: none"> • Connect the cable to correct input/output source. • Press the MENU button and increase BRIGHTNESS. • Remove lens cap.
Picture is displayed without sound.	<ul style="list-style-type: none"> • Audio wiring to projector is not correct. • The volume is set to minimum. • The volume is muted. 	<ul style="list-style-type: none"> • Connect the cable to correct input/output source. • Press the VOL button to increase Volume. • Press the MUTE button.
Color is weak and tint is incorrect.	<ul style="list-style-type: none"> • The color and tint have been adjusted incorrectly. 	<ul style="list-style-type: none"> • Adjust the color and tint correctly.
Picture is dark.	<ul style="list-style-type: none"> • The brightness and contrast has not been adjusted correctly. • The lamp needs to be replaced. 	<ul style="list-style-type: none"> • Adjust the brightness and contrast correctly. • Replace the lamp with a new one.
Picture is not clear.	<ul style="list-style-type: none"> • Projector is out of focus. 	<ul style="list-style-type: none"> • Adjust the focus and H. PHASE.
LAMP indicator lights red.	<ul style="list-style-type: none"> • Lamp will not ignite. • Temperature inside projector is too hot. 	<ul style="list-style-type: none"> • Turn off power and let cool for 20 minutes, then restart. • If problem persists call your dealer. • Check and clear blocked ventilation holes. • Check and clean air filter.
LAMP indicator blinks red.	<ul style="list-style-type: none"> • Lamp access door on bottom of case is open. • The lamp usage has reached maximum operating hours. 	<ul style="list-style-type: none"> • Ensure lamp access door is closed. • Replace the lamp.
TEMP indicator blinks red.	<ul style="list-style-type: none"> • Cooling fan not operating. 	<ul style="list-style-type: none"> • Contact your dealer.

Messages/Solutions

Error Message Displays	Cause	Solution
NO INPUT IS DETECTED.	The projector is not detecting a signal.	Check cable connections to input device. If input device not connected to this input mode, switch to next mode.
SYNC IS OUT OF RANGE.	The horizontal frequency of input signal exceeds projector capability.	Switch projector to correct resolution. See Appendix.
CHANGE THE LAMP. AFTER REPLACING LAMP, RESET THE LAMP TIME.	Nearing end of normal lamp operating time.	Change the projector lamp and reset the lamp operation hours to zero.
CHANGE THE LAMP. AFTER REPLACING LAMP, RESET THE LAMP TIME. THE POWER WILL TURN OFF AFTER * HR.	Remaining lamp operation time = 20 hours or less. *Indicates number of hours until power turns off automatically.	Change the projection lamp and reset the lamp operation hours to zero.
CHANGE THE LAMP. (blinking)	Normal lamp operating time has expired. Safety feature shuts projector down after 10 minutes.	Change the projector lamp and reset the lamp operation hours to zero.

Section 7: Troubleshooting

Indicator Lights

POWER Indicator Light	LAMP Indicator Light	TEMP Indicator Light	Meaning
Lights orange	Turns off	Turns off	Standby status
Blinks green	Turns off	Turns off	Warming up. Wait.
Lights green.	Turns off.	Turns off.	Operation status.
Blinks orange.	Turns off.	Turns off.	Cool down.
Lights red.	Lights red.	Turns off.	The lamp does not light. Wait approx. 20 minutes before turning on power again. If indicator still lights, the lamp may have failed. Replace lamp.
Lights red.	Blinks red.	Turns off.	A lamp has not been inserted or the lamp cover is missing. Turn off projector, disconnect power and wait 45 minutes for projector and lamp to fully cool. Replace lamp and/or lamp cover door, then re-connect power and turn on projector again.
Lights red.	Turns off.	Blinks red.	The cooling fan is not operating. Switch power off, and wait for 20 minutes until the equipment cools. Check to see if air filter or ventilation openings are blocked. Clear any obstructions.
Lights red.	Turns off.	Lights red.	Internal overheating. Turn off projector, disconnect power, and let cool for 20 minutes. Check to see if air filter or ventilation openings are blocked. Clear any obstructions.

Section 7: Troubleshooting

Service Information

For product information, product assistance, service information, or to order accessories, please call:

- In U.S. or Canada: **1-800-328-1371**
- In other locations, contact your local 3M sales office.

Section 8: Accessories

Accessories

	Part Number
UHB lamp module, 130 W	78-6969-9205-2
Power cord (US)	78-8118-8102-4
Power cord (UK)	78-8118-8101-6
Power cord (Germany)	78-8118-8103-2
VGA cable	78-8118-3401-5
Mac adapter	78-8118-3308-2
RCA video cable	78-8118-8482-0
Stereo mini jack cable	78-8118-8483-8
Remote Control	78-8118-8481-2

Not Included with Basic Packet

	Part Number
Ceiling mount	78-6969-9206-0
Adjustable height suspension	78-6969-8312-7
Shipping case	78-6969-9204-5
Soft carry case	78-6969-9203-7
RS-232 control cable	78-8118-3312-4
USB mouse cable	78-8118-8186-7
Deluxe Mouse Emulation Kit	78-6969-9233-4
S-VHS video cable	78-8118-3238-1

How to Order

Please order these parts through your dealer, or contact 3M Customer Service at the following number:

- In U.S. or Canada: **1-800-328-1371**
- In other locations, contact your 3M sales office.

The contents of this manual are subject to revision without prior notice.

3M assumes no responsibility for the infringement of special rights of a third party or other rights that may arise out of the information contained in this manual.

Reproduction of this manual in any form without prior permission is strictly prohibited.

3M will replace the manual if any pages are missing or collated incorrectly.

Important Notice

All statements, technical information, and recommendations related to 3M's products are based on information believed to be reliable, but the accuracy or completeness is not guaranteed. Before using this product, you must evaluate it and determine if it is suitable for your intended application. You assume all risks and liability associated with such use. Any statements related to the product which are not contained in 3M's current publications, or any contrary statements contained on your purchase order shall have no force or effect unless expressly set forth in a written agreement signed by an authorized officer of 3M.

Warranty and Limited Remedy. This product will be free from defects in material and manufacture for a period of two years from the date of purchase. Exclusion to Warranty: The lamps are considered a consumable item and are warranted for 90 days or 180 hours, whichever occurs first. **3M MAKES NO OTHER WARRANTIES, INCLUDING BUT NOT LIMITED TO, ANY IMPLIED WARRANTY OF MERCHANTABILITY OR FITNESS FOR A PARTICULAR PURPOSE.** If this product is defective within the warranty period stated above, your exclusive remedy shall be, at 3M's option, to replace or repair the 3M product or refund the purchase price of the 3M product.

Limitation of Liability. Except where prohibited by law, 3M will not be liable for any loss or damage arising from this 3M product, whether direct, indirect, special, incidental or consequential regardless of the legal theory asserted.

Let us help you make the most of your next presentation. We offer everything from presentation supplies to tips for better meetings. And we're the only transparency manufacturer that offers a recycling program for your used transparencies. For late-breaking news, handy reference and free product samples, call us toll-free in the continental United States and Canada, 24 hours a day, or visit our Internet Website.



<http://www.3m.com/meetings>
e-mail: meetings@mmm.com

3M Austin Center
Building A145-5N-01
6801 River Place Blvd.
Austin, TX 78726-9000

3M Canada
P.O. Box 5757
London, Ontario
N6A 4T1

3M Mexico, S.A. de C.V.
Apartado Postal 14-139
Mexico, D.F. 07000
Mexico

3M Europe
Boulevard de l'Oise
95006 Cerge Pontoise Cedex
France

Litho in Japan
Copyright © 2000 3M IPC.
All Rights Reserved
78-6970-9032-8 Rev. B

